

NAVIGATOR[®]

PRODUCT DATA SHEET

Issue Number: **03**
Date: 19/06/2020

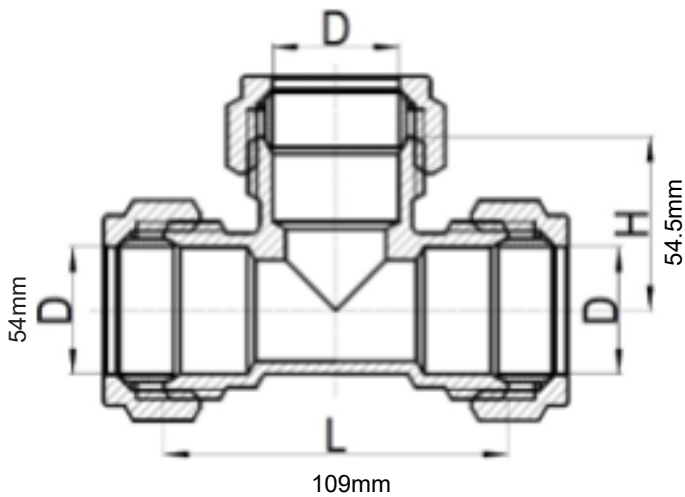

Product Code: COET-54

Product Description: 54mm Equal Tee

Product Type: Compression

Suitable For: Hot / Cold Water

Bag Qty: 1

Box Qty: 10

Item Weight: 0.9621Kg

Material: 1. Brass

Operating Temperature: < 90°C

Max Operating Pressure: 16 Bar

Approvals: WRAS Approved

This Technical Data Sheet is for Guidance only. As part of our commitment to continual improvement to our products, we reserve the right to amend this data sheet without prior notice. Please Note: weights are approximate and may vary.

NAVIGATOR

Tel: +44 (0)1234 781234
Fax: +44 (0)1234 781808
Email: sales@navigatormsl.com
www.navigatormsl.co.uk

Navigator MSL Ltd,
Mill Road, Sharnbrook,
Bedford, Bedfordshire,
England, MK44 1NP.